



materia infinita[®]

LAYING INSTRUCTIONS

REV_12/21



CLADDING WITH NOVOWOOD SKIN AIR SYSTEM

LIST OF MATERIALS TO BE USED

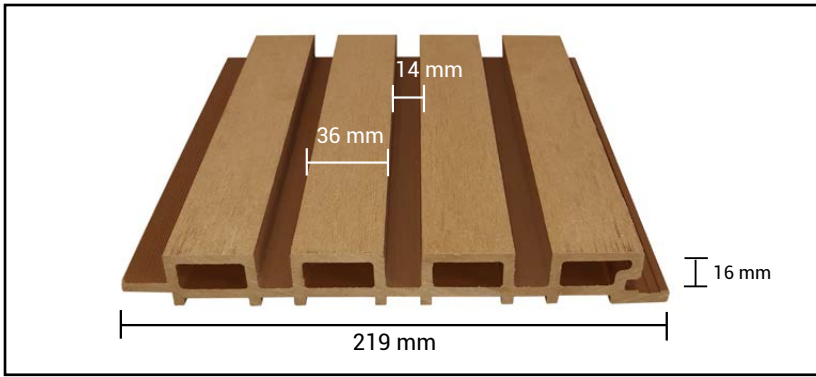

SKIN AIR STAVES
219x26x2900 mm
cod. 219H26
AVERAGE USE 1,72 pcs/m²



OMEGA WALL PROFILE
cod. 90H25
AVERAGE USE 3,00 m/m²



FASTENINGS FOR SKIN AIR (SCREWS + PLATES)
COLOUR BLACK OR STEEL
cod. F-SA
AVERAGE USE 15 pcs/m²

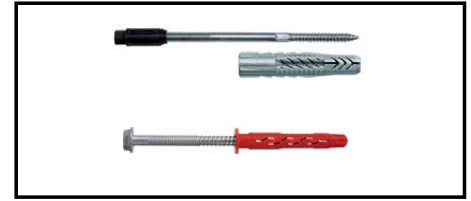

ANCHORS TO SUBSTRATE

IMPORTANT NOTES

CORRECT USE OF THE MATERIAL



Novowood products are covering materials that, despite their mechanical strength characteristics, must always be laid on a supporting substructure of a suitable size.

THERMAL EXPANSION

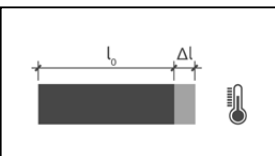

Wood plastic composite is subject to slight thermal expansion due to the presence of a small amount of HDPE plastic in its mix. The expansion index defined in the data sheet is equal to **0.04 mm/m/°C**. It is therefore recommended to calculate the grouting between the staves heads according to external temperatures during laying and to the annual thermal variation forecast.

VENTILATION AND AIRSPACE

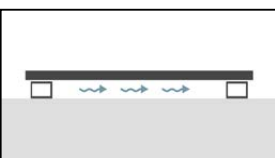

It is essential to **ALWAYS** leave an airspace between the slats and the supporting surface to allow ventilation. This is usually done by using subconstruction framework joists.

FIXINGS

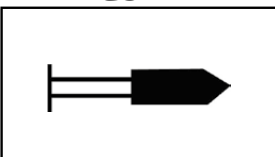

It is necessary to evaluate the fixing system which is more suitable according to the typology of substrate and the loads.

HUE VARIATIONS OF DIFFERENT LOTS

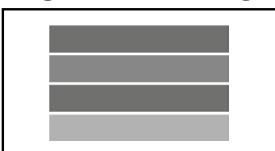

Novowood is a wood plastic composite produced by extrusion, therefore it is possible to have little hue variations between different lots produced. It is advisable to lay the material picking up staves from different pallets.

STEP BY STEP CLADDING INSTALLATION GUIDE

1 SUBCONSTRUCTION FRAMEWORK JOISTS

Subconstruction framework aluminium joists must be laid respecting all the distances necessary to support the whole covering system.

Make sure to reduce any irregularities on the wall in order to obtain a flat surface.

The section sizing of the subconstruction framework joists must be verified by a qualified technician on the basis of the specific project.

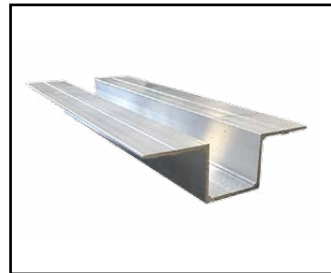

Subconstruction framework aluminium joists

1.1 HOLES ON JOISTS

Drill the aluminium bars indicatively every 1000/1500 mm.

It is necessary to practise the holes evaluating the possible thermal expansion of aluminium.



The right distance must still be verified by a qualified technician depending on the load to be maintained and the type of bearing wall.

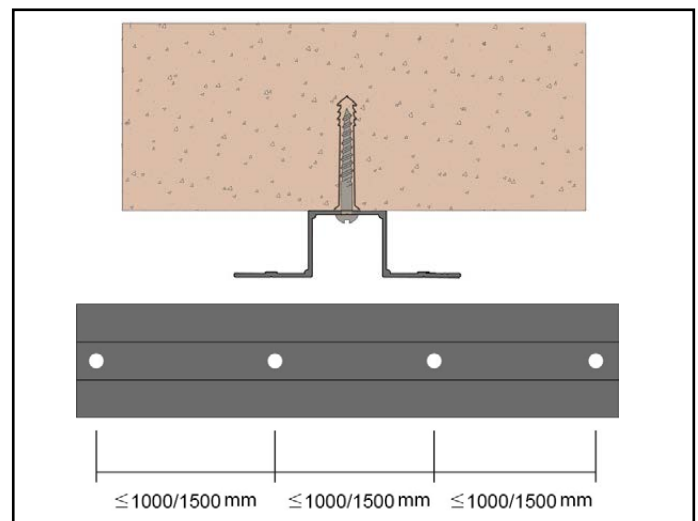

1.2 POSITIONING JOISTS ON A WALL

Fix the joists to the wall while maintaining a maximum distance of 500 mm.

Place the joists in correspondence with the heads of the staves as indicated in step 2.8 of the second chapter (staves).



The right distance will still be verified by a qualified technician depending on the load to be maintained and the typology of bearing wall.

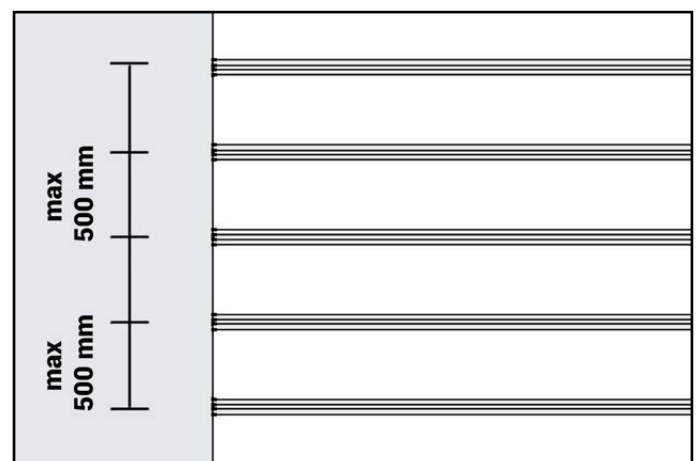

Staves can be installed either horizontally or vertically.

1.3 POSITIONING JOISTS NEXT TO THE EDGE OF THE WALL

Make sure to do NOT leave a space bigger than 50 mm when you are going to lay the joists near the edge of the wall.

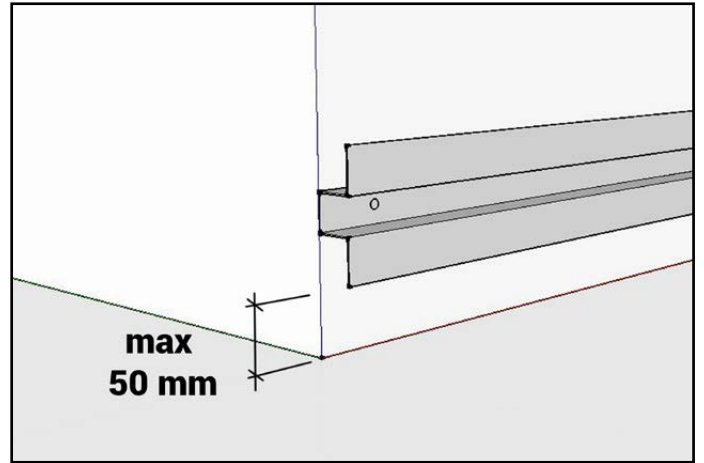

1.4 JOISTS POSITIONING IN CASE OF DOORS AND WINDOWS

If there are any doors and / or windows on a wall, fix the currents beside them, as shown in the figure, leaving a maximum space of 50 mm from the edge.

For the closure of intrados and openings it is advisable to use tinsmithery, to be laid after the cladding.

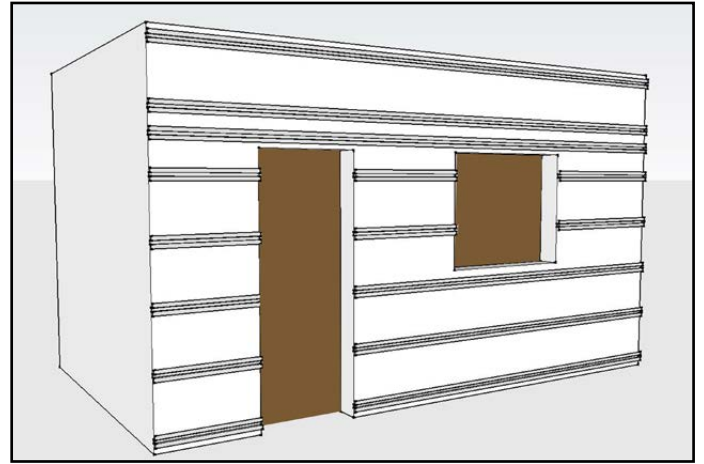

2 POSA DELLE DOGHE SKIN AIR

Skin Air staves can be installed onyl on one side



CAUTION

Wood plastic composite is subject to slight thermal expansion ($0.04 \text{ mm/m/}^{\circ}\text{C}$). Ensure that recommended distances are observed.



2.1 STAVE DISTANCE FROM THE GROUND

It is necessary to leave a space between the first stave and the ground of **at least 10 mm**, to allow the material ventilation.

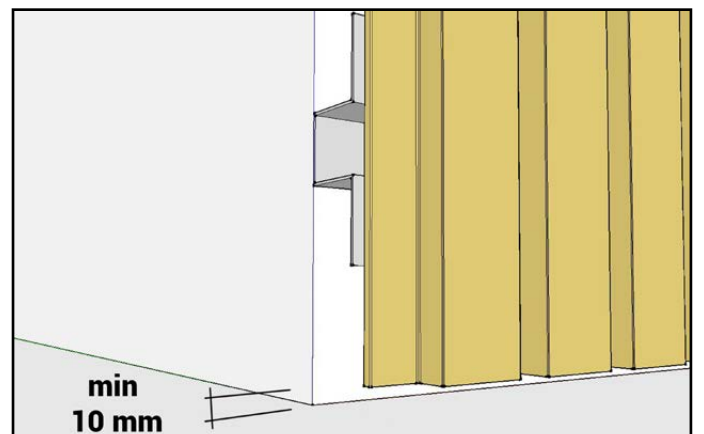



2.2 DRILLING FIRST STAVE

Make on the stave holes in correspondance of the fastenings to the subconstruction framework joists.

In correspondance of about the half of the stave the diameter of the hole must be 4 mm, all the other holes must have a diameter of 7 mm to allow the thermal expansion of the material (as shown in the picture).

On the first stave holes must be made on both sides.

LEGEND:

-  Hole with diameter 4 mm (fixed pont)
-  Hole with diameter 7 mm (thermal expansion)

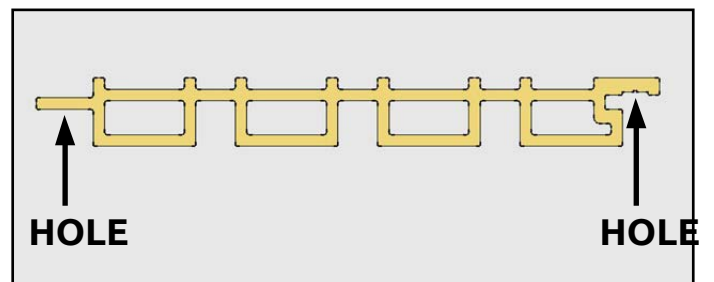
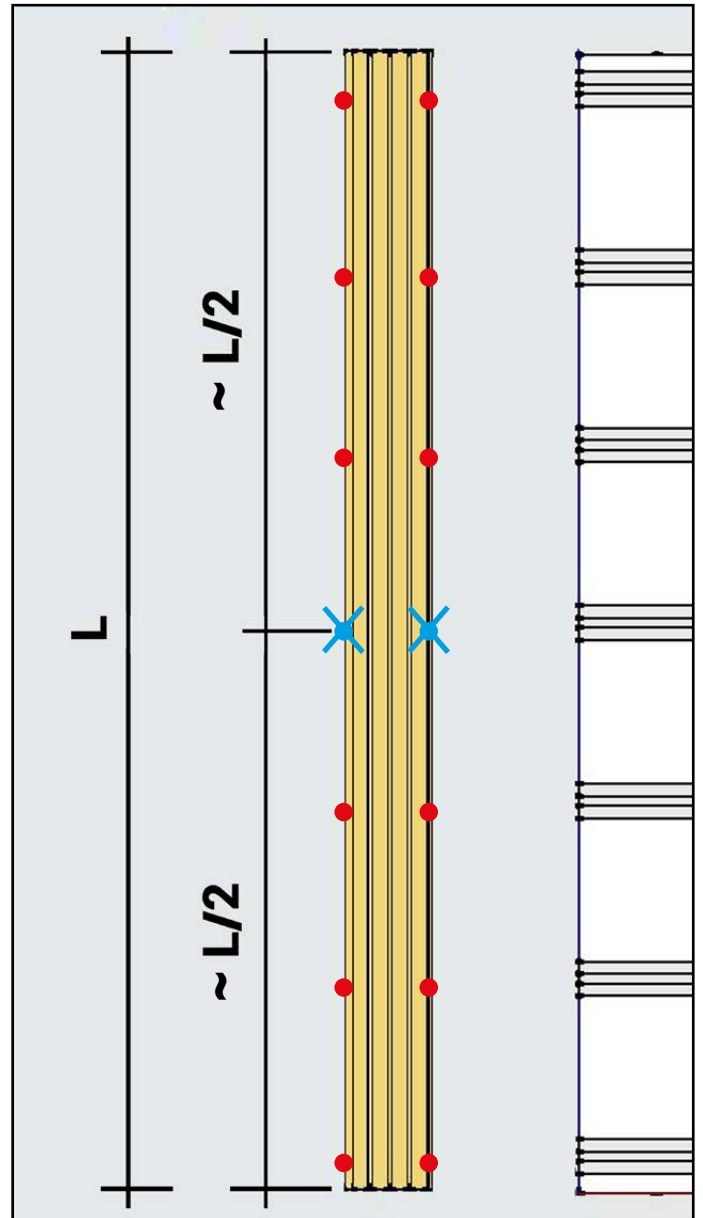

2.3 FASTENING FIRST STAVE

Fasten the first stave to the subconstruction framework joists with Novowood screws and plates, in correspondance of the holes made on the stave (as shown in picture)



CAUTION

Pay particular attention to the orientation of this stave as all the subsequent ones will follow the same direction.

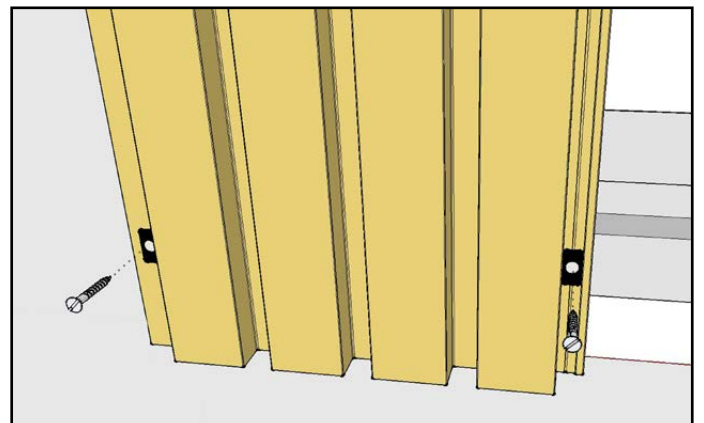



2.4 DRILLING SECOND STAVE

Make on the stave holes in correspondance of the fastenings to the subconstruction framework joists.

It is necessary to make the holes only on the side of the stave with the groove.

In correspondance of about the half of the stave the diameter of the hole must be 4 mm, all the other holes must have a diameter of 7 mm to allow the thermal expansion of the material (as shown in the picture).

LEGEND:

-  Hole with diameter 4 mm (fixed pont)
-  Hole with diameter 7 mm (thermal expansion)

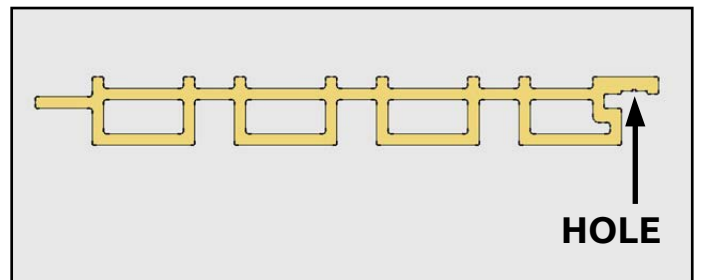
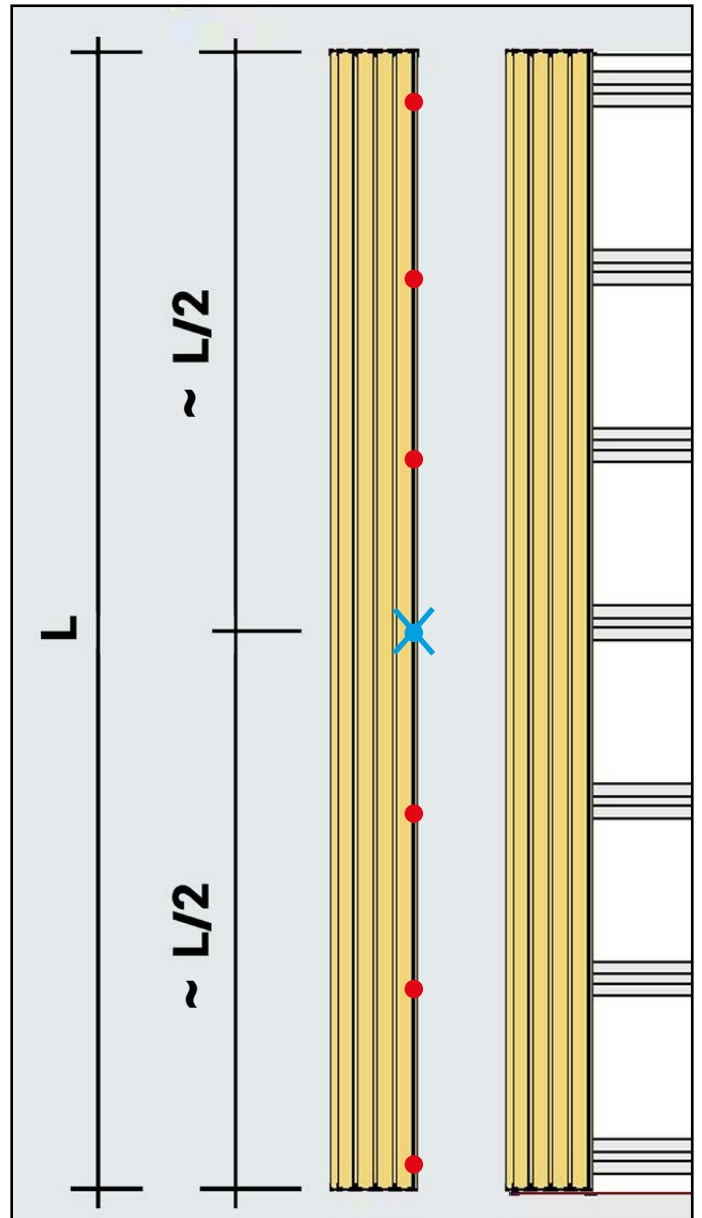

2.5 POSITIONING SECOND STAVE

Position the second stave fitting it in the first one as shown in the picture.

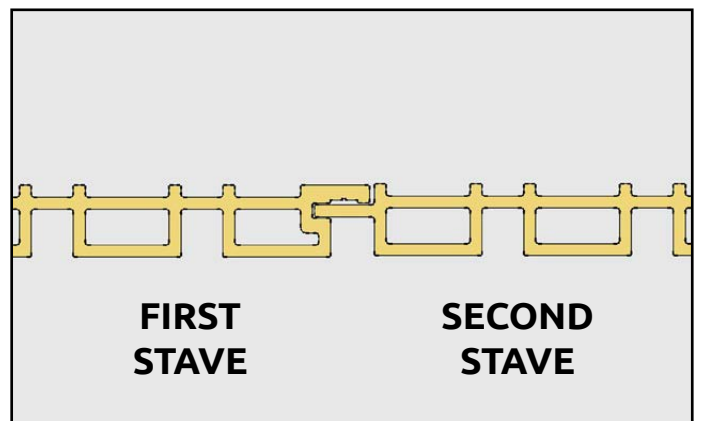

2.6 FASTENING SECOND STAVE

Fasten the second stave to the subconstruction framework joists with Novowood screws and plates, in correspondence of the holes made on the stave (as shown in picture)

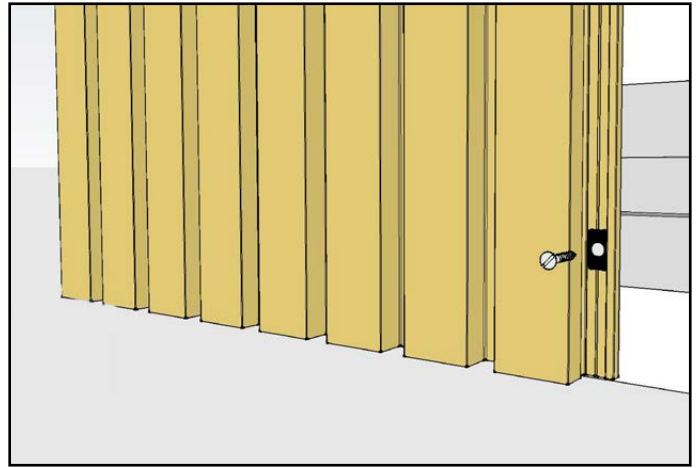

2.7 COMPLETING INSTALLATION

Repeat steps 2.4, 2.5 and 2.6 until the area to be covered is complete.

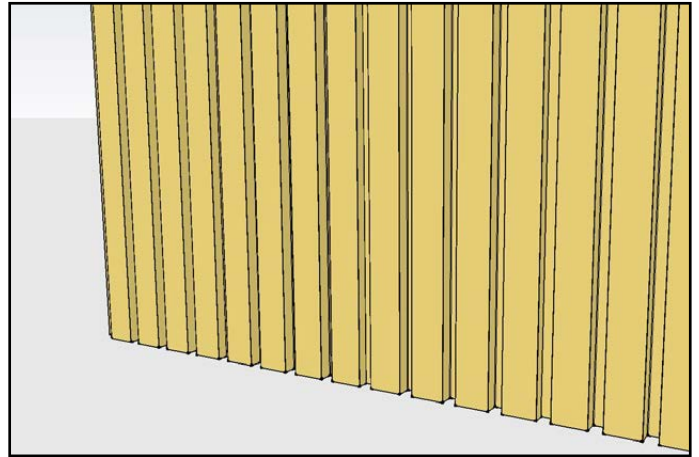

2.8 POSITIONING ADJACENT STAVES

Leave a space of about **5 mm** between two adjacent staves to allow the natural thermal expansion of the wood plastic composite. The distance must be evaluated depending on the temperature at moment of the installation and annual climate variations, considering that the solar radiation sensibly modifies the temperature of the material.

- Laying at **10°C** = distance **6 mm** for staves with a length of 2900 mm.
- Laying at **20°C** = distance **3 mm** for staves with a length of 2900 mm.
- Laying at t_{max} = distance **0 mm** for staves with a length of 2900 mm.



CAUTION

The 2 adjacent staves will stick to the same omega joist with 2 clips.

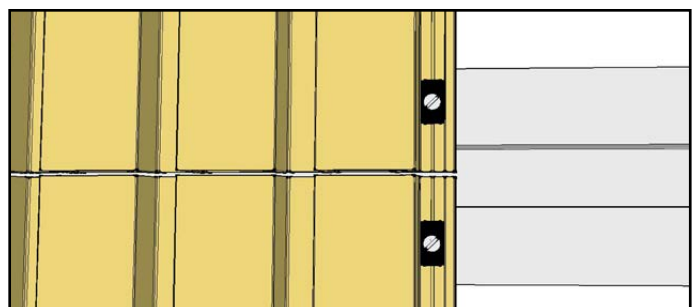
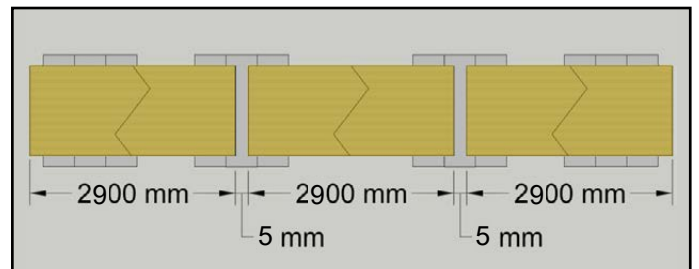

2.9 POSITIONING STAVES ON THE EDGE OF THE WALL

Cut the stave in order to adapt it to the dimension of the wall.

Make a hole on it and fasten with a screw and plate in correspondence of the portion of 14 mm which is closer to the edge.

It is recommended to cover everything with a Corner Novowood composite wood profile or metallic skirt.

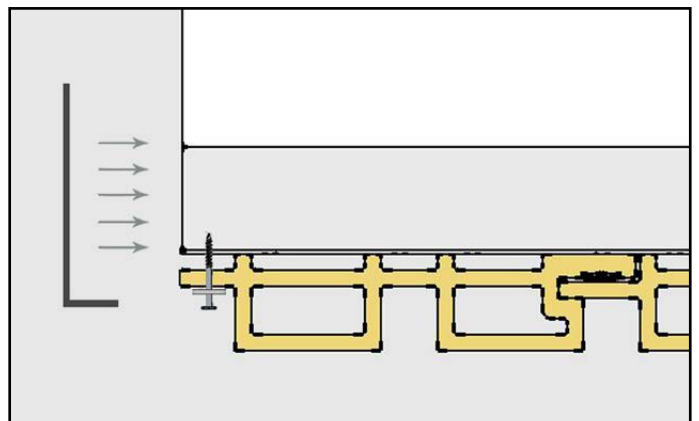

2.10 WASTAGE

Wastage varies depending on the geometry of the project. A regular shape, for example a square or a rectangle, will produce less waste, while a complex shape with a high number of joints, angles or irregular shapes, will produce more waste. In general, it is estimated to be between 5-10%.

2.11 MAINTENANCE AND CLEANING

Novowood wood plastic composite does not require special maintenance and it is easy to clean thanks to the studied combination of fibres, polymers and additives. In order to reduce the accumulation of residues on the surface it is advised to monthly wash the Wood Plastic Composite with cleaning products (supplied on request) and in order to maintain the warranty it is necessary to provide at least one annual cleaning with "WPC Cleaner" (supplied on request). If you use the pressure washer, keep the nozzle at a distance of 30 cm from the floor.

The accumulation of organic material on the surface, with the passage of time, may form localised moulds which can be removed using hot water and "WPC Cleaner". If moulds, algae and fungi have settled for a long time, often the material needs further treatment.

However, the inconvenience can be reduced by keeping the decking clean, dry and ensuring good ventilation.

In order to remove localized stains it is advisable to use a special spray "WPC stains remover" (supplied upon request) which may produce a slight hue change in the intervention area.

INFORMATION ON NOVOWOOD'S LIABILITY

The distances to be observed and the method of installation will be evaluated according to the needs of the client and the contractor during laying. The company does not assume any liability for negligence in the installation of NOVOWOOD products.

Please check possible updates of the manuals on the website www.novowood.it in the download section.



NOVOWOOD
HEADQUARTER
Via E. da Rotterdam, 29
44122 Ferrara (FE)

+39 0532 732737
info@novowood.it

www.novowood.it